

**VERDERFLEX<sup>®</sup>**

# Peristaltic Hose Pump

Operating manual

Dura 55/60

Version 00



**VERDER**  
passion for pumps



Version 00



The information in this document is essential for the safe operation and servicing of Verderflex® Dura pumps. This document must be read and understood thoroughly prior to installation of unit, electrical connection and commissioning.

## Table of Contents

<b>1.</b>	<b>Declaration of Conformity .....</b>	<b>5</b>
<b>2.</b>	<b>About This Document.....</b>	<b>7</b>
2.1	Target groups .....	7
2.2	Warnings and symbols.....	7
<b>3.</b>	<b>Safety .....</b>	<b>8</b>
3.1	Intended use .....	8
3.2	General safety instructions.....	8
3.2.1	Product safety .....	8
3.2.2	Obligation of the operating company .....	8
3.2.3	Obligation of personnel.....	9
3.3	Specific hazards.....	9
3.3.1	Hazardous pumped liquids .....	9
3.3.2	Sharp edges.....	9
3.3.3	ATEX environment .....	9
<b>4.</b>	<b>Transport, Storage and Disposal.....</b>	<b>10</b>
4.1	Transport .....	10
4.1.1	Unpacking and inspection on delivery .....	10
4.1.2	Lifting .....	10
4.2	Storage conditions .....	10
4.3	Interim storage after using the pump .....	10
4.4	Interim storage before using the pump .....	10
4.5	Disposal .....	11
<b>5.</b>	<b>Layout and Function.....</b>	<b>11</b>
5.1	Design details.....	11
5.2	Labelling.....	11
5.2.1	Name plate.....	11
5.4	Bearings and lubrication.....	12
5.3	Layout .....	12
<b>6.</b>	<b>Installation and Connection .....</b>	<b>13</b>
6.1	Preparing for installation .....	13
6.1.1	Checking the ambient conditions.....	13
6.1.2	Preparing the installation site.....	13
6.1.3	Preparing the foundation and surface.....	13
6.2	Installation at site .....	13
6.3	Planning the pipes.....	14
6.3.1	Specifying supports and flange connections.....	14
6.3.2	Specifying nominal diameters .....	14
6.3.3	Specifying pipe lengths .....	14
6.3.4	Optimizing cross-section of pipework .....	14
6.3.5	Providing safety and control devices (recommended).....	14
6.4	Electrical connection .....	15
6.4.1	Installing the motor and gearbox (where not supplied).....	15
6.4.2	Connecting to power supply.....	15
6.4.3	Shimming.....	16
6.5	Installing the hose .....	16
6.6	Flange assembly .....	17
6.6.1	Port flange assembly without insert .....	17
6.6.2	Port flange assembly with insert .....	17
6.7	Filling the pump with lubricant.....	18
6.7.1	Fitting the inspection window .....	18

## Table of Contents

6.8	Connecting the pipes .....	18
6.8.1	Installing the piping .....	18
<b>7.</b>	<b>Operation .....</b>	<b>19</b>
7.1	Pre-commissioning the pump.....	19
7.1.1	Checking the direction of rotation with dry pump .....	19
7.1.2	Starting the Pump .....	19
7.1.3	Switching OFF the pump .....	19
7.2	Commissioning the pump.....	20
7.2.1	Switching ON the Pump.....	20
7.2.2	Switching OFF the pump (refer to 7.1.3).....	20
7.3	Shutting down the pump .....	20
7.4	Start-up following a shutdown period .....	20
7.5	Operating the standby pump.....	20
<b>8.</b>	<b>Inspection, Maintenance and Repair .....</b>	<b>21</b>
8.1	Inspection.....	21
8.2	Maintenance.....	21
8.2.1	Cleaning the pump.....	21
8.2.2	Cleaning protocol for hoses .....	21
8.2.3	Maintenance schedule .....	23
8.3	Repair.....	24
8.3.1	Preparations for dismounting .....	24
8.3.2	Returning the pump to the manufacturer .....	24
8.3.3	Rebuild / Repair .....	24
8.4	Hose change.....	25
8.4.1	Dismounting the hose .....	25
8.4.2	Re-installing the hose, port flanges, lubricant refill and fitting the inspection window.....	25
8.5	Ordering spare parts .....	25
<b>9.</b>	<b>Troubleshooting .....</b>	<b>26</b>
9.1	Pump malfunctions.....	26
<b>10.</b>	<b>List of Tables and Figures .....</b>	<b>29</b>
<b>11.</b>	<b>Technical specifications .....</b>	<b>30</b>
11.1	Pump specifications .....	30
11.2	Ambient conditions.....	30
11.3	Tightening torques .....	30
11.4	Preservatives .....	30
11.5	Cleaning agents (after hose is removed).....	30
11.6	Lubricants.....	30
11.7	Number of shims required.....	30
11.8	Rotor setting distance .....	30
<b>12.</b>	<b>Trademarks .....</b>	<b>31</b>
<b>13.</b>	<b>Document History .....</b>	<b>31</b>

# 1. Declaration of Conformity (EC)



**EC declaration of conformity according to machinery directive, appendix II A**

We,  
 VERDER Ltd., Unit 3 California Drive, Castleford  
 hereby declare that the following machine adheres to the relevant EC directives detailed below:

Designation  
**Dura 55**  
**Dura 60**

- EC directives:
- Machinery Directive (2006/42/EC)
  - Low-voltage Directive (2014/35/EU)
  - RoHS Directive (2011/65/EU) and Delegated Directive (2015/863/EU)

- Applicable harmonized standards:
- BS EN ISO 12100:2010 - Safety of machinery - General principles for design - Risk assessment and risk reduction

The pumps, to which this declaration refers, may only be put into operation after they have been installed in the way prescribed by the manufacturer and, as the case may be, after the complete system of which these pumps form part, has been made to fulfil the requirements of Machinery Directive 2006/42/EC.

<p><b>Manufacturer</b>                  VERDER Ltd.                  Unit 3 California Drive                  Castleford                  WF10 5QH                  UK</p>	<p><b>Authorised Representative Established in EU                  (in accordance with Article 4, Regulation (EU) 2019/1020)</b>                  Verder Liquids B.V                  Utrechtseweg 4a                  3451 GG Utrecht                  Netherlands</p>	
<p><b>Date: 07 / 08 / 2024</b></p>	<p><b>Company Stamp / Signature:</b>    <b>Anthony Beckwith</b>                  Head of Engineering</p>	

## Declaration of Conformity (UK)



**In accordance with the UK Supply of Machinery (Safety) Regulations 2008, No 1597 ANNEX II, Part I, Section B**

We,  
 VERDER Ltd., Unit 3 California Drive, Castleford  
 hereby declare that the following machine adheres to the relevant UK legislation detailed below:

Designation

**Dura 55**

**Dura 60**

UK Legislation:

- Supply of Machinery (Safety) Regulations 2008
- The Restriction of the Use of Certain Hazardous Substances in Electrical and Electronic Equipment Regulations 2012
- Electrical Equipment (Safety) Regulations 2016

The following designated standard(s) has been applied:

- BS EN ISO 12100:2010 - Safety of machinery - General principles for design - Risk assessment and risk reduction

The pumps, to which this declaration refers, may only be put into operation after they have been installed in the way prescribed by the manufacturer and, as the case may be, after the complete system of which these pumps form part, has been made to fulfil the requirements of The Supply of Machinery (Safety) Regulations 2008.

<p><b>Manufacturer</b></p>	<p>VERDER Ltd.                  Unit 3 California Drive                  Castleford                  WF10 5QH                  UK</p>
<p><b>Date: 07 / 08 / 2024</b></p>	<p><b>Company Stamp / Signature:</b></p>  <p><b>Anthony Beckwith</b>                  Head of Engineering</p>

## 2. About This Document

The Verderflex Dura 55 and 60 are peristaltic pumps that have been developed using the latest technology and have been subject to continuous quality control. These operating instructions are intended to facilitate familiarisation with the pump and its designed use. This manual will act as a guide for operating the pump. You are advised to follow these guidelines to operate the pump correctly. These operating instructions do not take local regulations into account. The operator must ensure that such regulations are strictly observed by all, including the personnel responsible for installation.

### 2.1 Target groups

Target Groups	Duty
Operating Company	<ul style="list-style-type: none"> <li>▶ Keep this manual available at the operating site of the pump.</li> <li>▶ Ensure that personnel read and follow the instructions in this manual and any other applicable documents, especially all safety instructions and warnings.</li> <li>▶ Observe any additional rules and regulations referring to the system.</li> </ul>
Qualified personnel, fitter	<ul style="list-style-type: none"> <li>▶ Read, observe and follow this manual and the other applicable documents, especially all safety instructions and warnings.</li> </ul>

Table 1. - Target groups

### 2.2 Warnings and symbols



Warning	Risk Level	Consequences of disregard
	Immediate risk	Death, serious bodily harm
	Potential acute risk	Death, serious bodily harm
	Potential hazardous situation	Potential damage to the pump
<b>Note</b>	For information	Possible incorrect use/maintenance of pump

Table 2. - Warnings used in the manual



Symbol	Meaning
	Safety warning sign in accordance with DIN 4844 - W9 <ul style="list-style-type: none"> <li>▶ Take note of all information highlighted by the safety warning sign and follow the instructions to avoid injury or death.</li> </ul>
▶	Instruction
1., 2.,	Multiple-step instructions
☐	Checklist
→	Cross-reference
	Information

Table 3. - Symbols used in the manual

## 3. Safety



The manufacturer does not accept any liability for damage resulting from disregard of this documentation.

### 3.1 Intended use

- ▶ Only use the pump to handle compatible fluids as recommended by the manufacturer (→11. Technical specifications).
- ▶ Adhere to the operating limits.
- ▶ Consult the manufacturer regarding any other use of the pump.
- ▶ Pumps delivered without a motor must be fitted with a motor in accordance with the provisions of EC Machinery Directive 2006/42/EC.

#### Prevention of obvious misuse (examples)

- ▶ Note the operating limits of the pump with regard to temperature, pressure, flow rate and motor speed (→11. Technical specifications).
- ▶ Do not operate the pump with any inlet/outlet valves closed
- ▶ Only install the pump as recommended in this manual.

For example, the following are not allowed:

- Installing the pump without proper support.
- Installation in the immediate vicinity of extreme hot or cold sources.

## 3.2 General safety instructions



Observe the following regulations before carrying out any work.

### 3.2.1 Product safety

- These operating instructions contain fundamental information which must be complied with during installation, operation and maintenance. Therefore, this operating manual must be read and understood both by the installing personnel and the responsible trained personnel / operators prior to installation and commissioning, and it must always be kept easily accessible within the operating premises of the machine.
- Not only must the general safety instructions laid down in this chapter on "Safety" be complied with, but also the safety instructions outlined under specific headings.
- Operate the pump only if it and all associated systems are in good functional condition.
- Only use the pump as intended, fully aware of safety and risk factors involved and the instructions in this manual.
- Keep this manual and all other applicable documents complete, legible and accessible to personnel at all times.
- Refrain from any procedure or action that would pose a risk to personnel or third parties.
- In the event of any safety-relevant faults, shut down the pump immediately and have the malfunction corrected by qualified personnel.
- The installation of the pump must comply with the

requirements of installation given in this manual and any local, national or regional health and safety regulations.

### 3.2.2 Obligation of the operating company

#### Safety-conscious operation

- Ensure that the following safety aspects are observed and monitored:
  - Adherence to intended use
  - Statutory or other safety and accident-prevention regulations
  - Safety regulations governing the handling of hazardous substances if applicable
  - Applicable standards and guidelines in the country where the pump is operated
- Make personal protective equipment available pertinent to operation of the pump.

#### Qualified personnel

- Ensure that all personnel tasked with work on the pump have read and understood this manual and all other applicable documents, including the safety, maintenance and repair information, prior to use or installation of the pump.
- Organize responsibilities, areas of competence and the supervision of personnel.
- Have all work carried out by specialist technicians only.
- Ensure that trainee personnel are under the supervision of specialist technicians at all times when working with the pump.

#### Safety equipment

Provide the following safety equipment and verify its functionality:

- For hot, cold and moving parts: safety guarding should be provided by the operating company.
- For potential build-up of electrostatic charge: ensure appropriate grounding if and when required.

#### Warranty

The warranty is void if the customer fails to follow any Instruction, Warning or Caution in this document. Verder has made every effort to illustrate and describe the product in this document. Such illustrations and descriptions are however, for the sole purpose of identification and do not express or imply a warranty that the products are merchantable or fit for a particular purpose, or that the products will necessarily conform to the illustration or descriptions.

Obtain the manufacturer's approval prior to carrying out any modifications, repairs or alterations during the warranty period. Only use genuine parts or parts that have been approved by the manufacturer.

For further details regarding warranty, refer to terms and conditions.



### 3.2.3 Obligation of personnel



It is imperative that the instructions contained in this manual are complied with by the operating personnel at all times.

- ▶ Pump and associated components:
  - Do not lean or step on them or use as climbing aid
  - Do not use them to support boards, ramps or beams
  - Do not use them as a fixing point for winches or supports
  - Do not de-ice using gas burners or similar tools
- ▶ Do not remove the safety guarding for hot, cold or moving parts during operation.
- ▶ Reinstall the safety equipment on the pump as required by regulations after any repair / maintenance work on the pump.

## 3.3 Specific hazards

### 3.3.1 Hazardous pumped liquids

Follow the statutory safety regulations when handling hazardous pumped liquids (e.g., hot, flammable, poisonous or potentially harmful).

Use appropriate Personal Protective Equipment when carrying out any work on the pump.

### 3.3.2 Sharp edges

Pump parts, such as the shims and impellers, can be sharp

- Use protective gloves when carrying out any work on the pump

### 3.3.3 ATEX environment

Failure to implement the necessary safety procedures and failure to disclose the intended use of a pump within an explosive atmosphere as laid down in latest EC Atex Directive 2014/34/EU will void all warranty for the product. (Refer warranty terms and conditions for more details).

Verder shall not be liable for any injuries, losses or damages including, but not limited to any personal injuries, anticipated or lost profits, incidental damages, consequential damages, costs, time charges, or other damages or losses, in connection with the instrument, its use or any replacement parts if the customer fails to follow any Instruction, Warning or Caution in this document.

## 4. Transport, Storage and Disposal

### 4.1 Transport

-  Always transport the pump in a stable position and ensure that the pump is securely attached to the pallet.

#### 4.1.1 Unpacking and inspection on delivery

1. Report any transport damage to the manufacturer/distributor immediately.
2. Retain the pallet if any further transport is required.

#### 4.1.2 Lifting



## DANGER

**Death or crushing of limbs can be caused by falling loads!**

1. Use lifting gear appropriate for the total weight to be transported.
2. Make sure the pump and accessories are lifted and moved by qualified lifting personnel equipped with suitable lifting gear.
3. Fasten the lifting gear to the lifting eye as shown in the following illustration.
4. Do not stand under suspended loads.



Figure 1. - Fastening lifting gear to pump

### 4.2 Storage conditions

1. Make sure the storage location meets the following conditions:
  - Dry, humidity not to exceed 85%, non-condensing
  - Out of direct sunlight
  - Frost-free; temperature range -5° to +45°C
  - Vibration-free
  - Dust-free
2. Depending on these conditions, it may be advisable to place a moisture-absorbing product, such as Silica gel, inside the pump's housing or to coat the pump's inner surfaces with moisture-repelling oil, such as WD40, whilst the pump is stored.
3. Hoses should be stored as supplied in their wrapper and should be stored away from direct sunlight, flat without any bends or kinks and at room temperature, with end caps fitted.
4. Lubricants should be stored under normal warehouse conditions with their caps securely fastened.
5. Gearboxes may require intermittent attention as indicated by the gearbox manufacturer's recommendations.

### 4.3 Interim storage after using the pump

- ▶ The hose should be removed from the pump.
- ▶ The pump housing lubricant should be drained.
- ▶ The pump housing should be washed out, allowed to dry and any external build-up of product removed.

### 4.4 Interim storage before using the pump



## CAUTION

**Pump damage caused by interim storage!**

- ▶ Allow the pump to reach ambient temperature before use.
- ▶ Please observe the storage recommendations and use by dates which apply to hose you may wish to bring into service after storage.

## 4.5 Disposal

With prolonged use, pump parts can be contaminated by hazardous pumped liquids to such an extent that cleaning may be insufficient.



### WARNING

#### Risk of poisoning and environmental damage by the pumped liquid or oil!

- ▶ Use suitable personal protective equipment when carrying out any work on the pump.
- ▶ Prior to disposal of the pump:
  - Drain and dispose the lubricant in accordance with local regulations.
  - Collect and dispose of any leaking pumped liquid or oil in accordance with local regulations.
  - Neutralize residues of pumped liquid in the pump.
- ▶ Dispose of the pump and associated parts in accordance with local regulations.

## 5. Layout and Function

 The medium to be pumped does not come into contact with any moving parts and is totally contained within the hose. A rotor passes along the length of the hose, compressing it. This motion forces the contents of the hose directly in front of the rotor to move forward along the length of the hose in a 'positive displacement' peristaltic movement. In the wake of the rotor's compressing action, the natural elasticity of the polymer reinforced rubber forces the hose to open and regain its round profile, creating suction pressure, which recharges the pump.

### 5.1 Design details

 Verderflex Dura 55/60 is a twin lobe, single rotor, peristaltic pump with quick-fit port flange design which clamps and seals in one easy movement to speed up hose replacement.

## 5.2 Labelling

### 5.2.1 Name plate

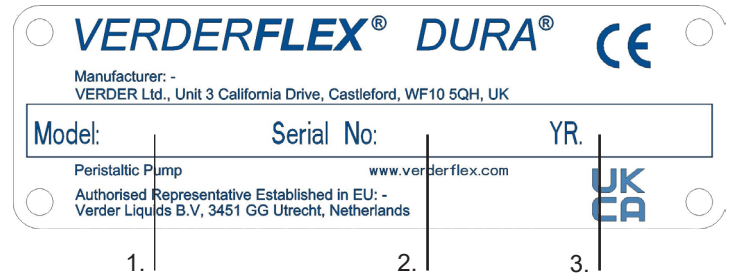



Figure 2. - Name plate

1. Pump Type
2. Serial Number
3. Year of Manufacture

 When requesting spares, the model and serial number should always be quoted.

## 5.3 Layout

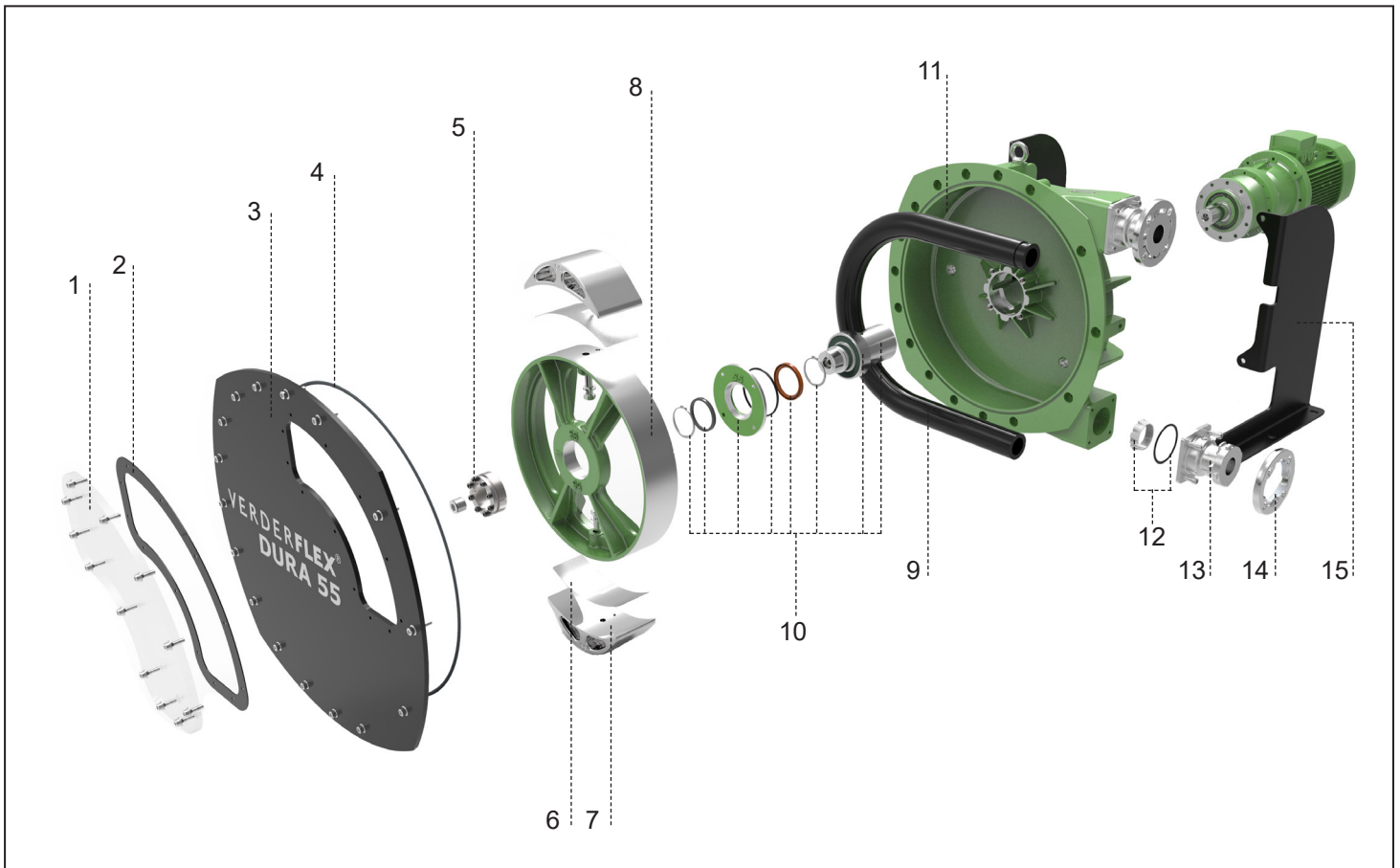

Figure 3. - Layout (Generic View)

1	Inspection Window	6	Shims	11	Pump Housing
2	Inspection Window Gasket	7	Rotor Shoe	12	Clamp Ring
3	Front Cover	8	Rotor	13	Port Flange
4	Front Cover O-Ring	9	Hose	14	¼ Turn Flange
5	Rotor Mounting Bush	10	Seal Kit and Bearing <sup>1)</sup>	15	Frames

<sup>1)</sup> Applies to Dura MKIII 55 & Dura 60 only.

<sup>2)</sup> Note: D60 parts are common to D55HF parts and specifications

## 5.4 Bearings and lubrication

- ▶ Pump: To be filled at installation with appropriate lubricant if not supplied pre-filled (→11. Technical specifications).
- ▶ Bearings are sealed units and need no additional lubricant.

## 6. Installation and Connection



### CAUTION

**Material damage due to unauthorized modification on pump!**

- ▶ Unauthorized modification will invalidate the warranty.

### 6.1 Preparing for installation

#### 6.1.1 Checking the ambient conditions

1. Make sure that the operating conditions are complied with (→ 11. Technical specifications)
2. Make sure the required ambient conditions are fulfilled (→ 11. Technical specifications)

#### 6.1.2 Preparing the installation site

- ▶ Ensure the installation site meets the following conditions:
  - Pump is freely accessible from all sides.
  - Sufficient space is available for the installation/ removal of the pipes and for maintenance and repair work, especially for the removal and installation of the hose.
- ▶ The pump and drive unit must not be installed in direct sunlight or exposed to rain without suitable shade cover.

#### 6.1.3 Preparing the foundation and surface

- ▶ Make sure the foundation and surface meet the following conditions:
  - Level
  - Clean (no oil, dust or other impurities)
  - Capable of bearing the weight of the pump and all operating forces
  - Ensure the pump is stable and cannot tip over
  - Concrete foundation: Standard concrete strong enough to support the pump under load.

### 6.2 Installation at site

1. Lift the pump. (→ 4.1.2 Lifting)
2. Put the pump down at the installation site.
3. Bolt the pump down; use all 4 holes.

## 6.3 Planning the pipes

### 6.3.1 Specifying supports and flange connections

- When planning pipe runs take every possible operating condition into account:
  - Cold/warm medium
  - Empty/full
  - Unpressurized/pressurized
  - Positional change of the flanges
- Ensure that the pipe supports are designed to accommodate any movement from environmental or pressure imposed forces.

### 6.3.2 Specifying nominal diameters

-  Keep the flow resistance in the pipes as low as possible. Pipework immediately connected to both inlet and outlet port of the pump should be straight runs for at least 1 metre.

Ensure that nominal pipe diameter is at least 1.5 times nominal pump-hose diameter to reduce pulsation.

### 6.3.3 Specifying pipe lengths

- Keep pipework as short and direct as possible.
- To allow easy access when changing hoses, include a short, removable section adjacent to the port flanges.

### 6.3.4 Optimizing cross-section of pipework

- Avoid bending radii of less than 10r (r - the radii of nominal piping).
- Avoid abrupt changes of cross-section along the piping.

### 6.3.5 Providing safety and control devices (recommended)

#### Making provisions for isolating and shutting off pipes

-  For maintenance and repair work.

- ▶ Provide shut-off valves in the suction and discharge lines.

#### Allowing safe removal of product

- ▶ Include drainage taps in suction and discharge lines at the lowest point.

Dos	Don'ts
<p>1. Short pipe run to suction side</p> 	<p>Long pipe run to suction side</p> 
<p>2. Reduced Joints/Bends</p> 	<p>Multiple Joints/Bends</p> 
<p>3. Connecting pipe with diameter 1.5 times pump hose diameter</p> <p>Pipe ID 1.5 times hose ID</p> 	<p>Connecting pipe with smaller than pump hose diameter</p> <p>Pipe ID &lt; pump hose ID</p> 
<p>4. Pulsation dampener connected close to the pump</p> <p>Pulsation Dampener</p>  <p>Bellows</p>	<p>Pulsation dampener connected away from pump</p> <p>10% loss in dampener efficiency for every meter</p> 

Table 4. - Dos and don'ts

## 6.4 Electrical connection

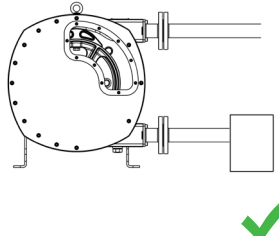
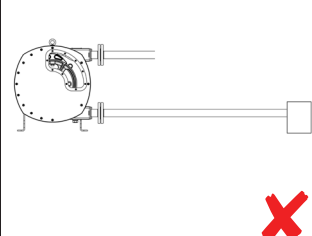
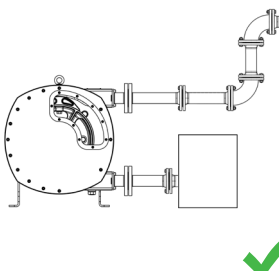
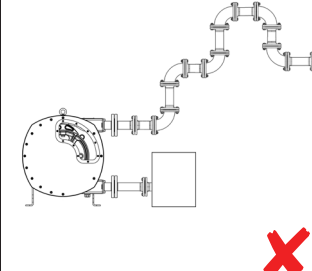
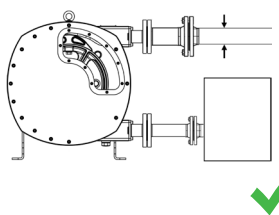
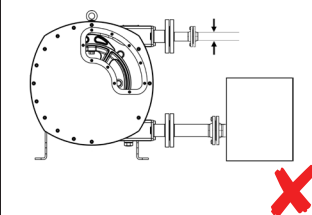
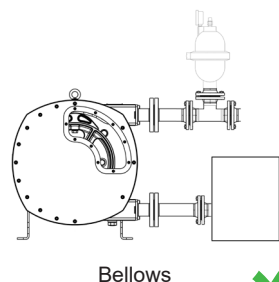
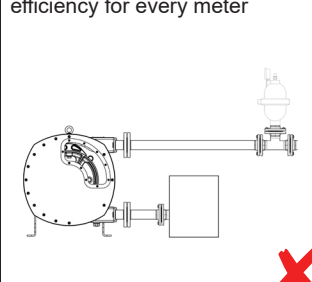

**DANGER**

Risk to health due to electric shock!

- ▶ All electrical work must be carried out by qualified electricians.

**Death or crushing of limbs caused by falling loads!**

- ▶ Use lifting gear appropriate for the total weight to be transported.
- ▶ Do not stand under suspended loads. Ensure the travel plug is removed and disposed correctly before the motor and gearbox is attached to the pump.

### 6.4.1 Installing the motor and gearbox (where not supplied)

#### Note

Bare shaft pumps are supplied with a back-plate support. Please make sure the back-plate support is removed before installing the gearbox and motor.

1. Remove the back-plate support

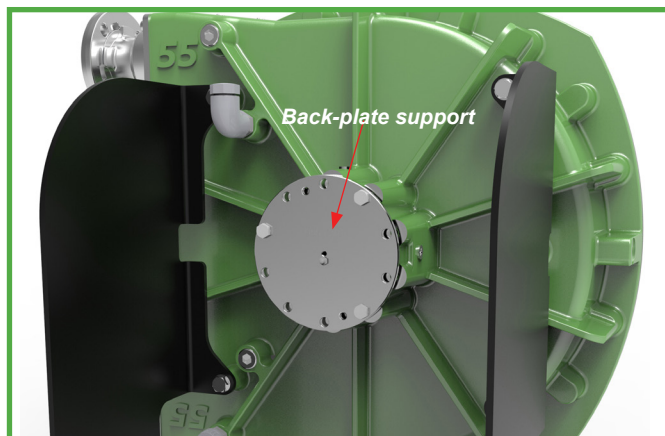

Figure 4. - Removing the back plate support

2. Attach the key to gearbox shaft.
3. Apply anti seize grease to the gearbox shaft.
4. Attach the gearbox to the pump housing.
5. Fit the eight M10 bolts to fasten the gearbox to the pump housing.
6. Use a torque wrench to apply tightening torque (→11. Technical specifications).

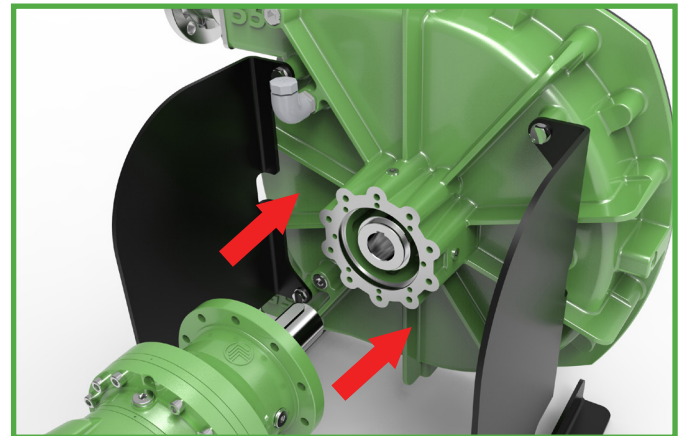

Figure 5. - Installing the gearbox

7. Apply anti seize grease to the motor shaft.
8. Attach the motor to the gearbox.
9. Use a torque wrench to apply tightening torque (→11. Technical specifications).

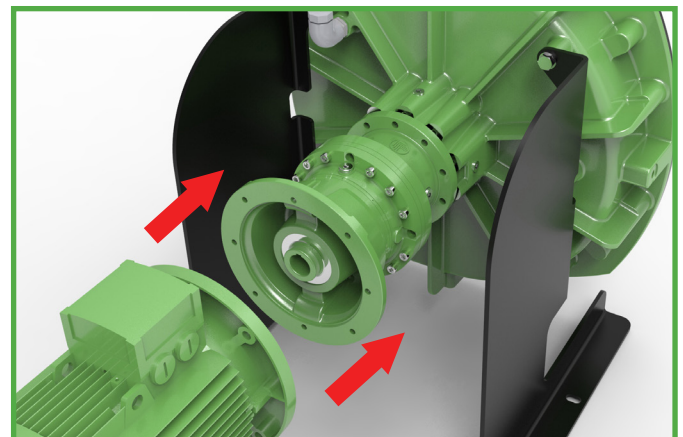



Figure 6. - Installing the motor

### 6.4.2 Connecting to power supply

1. Connect motor to the rated power supply. Ensure the correct gland is used and that the earth connection is made and secured.
2. Wiring instructions are available within the motor junction box.
3. Run the pump slowly to ensure correct rotation.

For more information on wiring the motor please refer to the relevant motor manual.

## 6.4.3 Shimming

 The pump must be shimmed for the required discharge pressure with the following procedure (→11. Technical specifications).

1. Rotate the pump so that a rotor shoe is visible through the inspection window.
2. Remove the inspection window and gasket. Leave the bolts on the inspection window for reassembly.
3. Loosen the shoe bolt.
4. Remove any existing shims.
5. Replace with correct number of shims for the required pressure (→11. Technical specifications).
6. Tighten the shoe bolt (→11. Technical specifications)
7. Repeat with the other rotor shoe.
8. Ensure the lubricant level is correct. (→11. Technical specifications)
9. Replace the window and gasket ensuring it is fitted the correct way with the bolts (→6.7.1 Fitting the inspection window).



Figure 7. - Shimming

## 6.5 Installing the hose

 Connect the motor to the power supply and run the pump slowly to ensure correct connection.

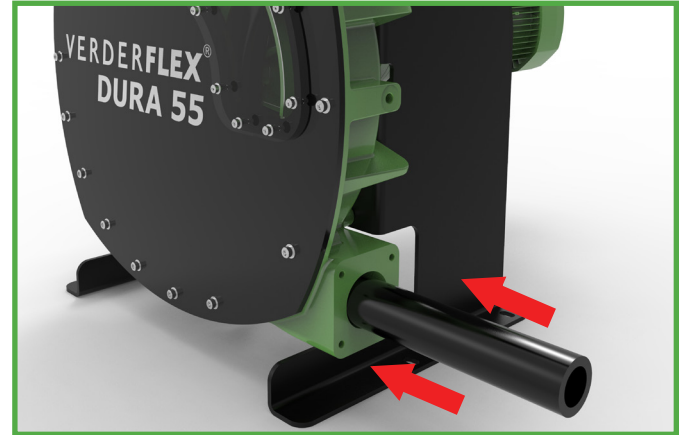

Figure 8. - Installing the hose

1. Lubricate the hose generously with Verderlube/Verdersil.
2. Insert the hose into the lower port.
3. Run the pump forward and stop when the hose protrudes from the other end by about 30mm.



## CAUTION

Ensure the hose is installed as indicated in 6.6 Flange assembly.



## 6.6 Flange assembly

### 6.6.1 Port flange assembly without insert



## CAUTION

Ensure the hose is installed as indicated in 6.6.3 Hose and flange assembly.

1. Insert the clamp ring over the hose with the large diameter towards the pump and ensure that the hose is protruding 5 to 10 mm past the clamp ring.

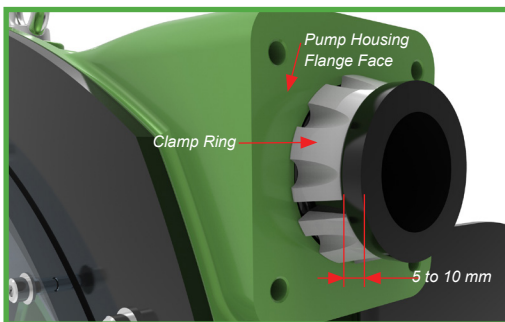

Figure 9. - Clamp ring inserted

2. Fit the O-ring to the port flange.
3. Apply some lubricant compatible with the pumped media to the port flange.
4. Make sure the O-Ring is in place in the face groove and push the port flange into the hose together.
5. Install the 4 bolts.
6. Tighten the bolts in a 1-3-4-2 sequence until the flange is evenly fitted. All 4 bolts should be fitted to each flange to avoid compromising the performance of the pump.
7. Ensure that the hose can be seen only through the drain port on the port flange (Figure 12).
8. Run the pump forward and stop when the hose is protruding 30 mm from the pump housing flange face. (Figure 10).
9. Repeat steps 1 - 6 to complete assembly.
10. Fit the ¼ turn flange connector to both ports.

### 6.6.2 Port flange assembly with insert

1. Load the insert into the port flange using either the clamp tool or two G clamps.
2. Fit the flange to the suction port by holding on to the flange-insert unit, pushing it in together.
3. Repeat steps 1 - 9 using "6.6.3.2 Port flange assembly with insert" to complete assembly.

### 6.6.3 Hose and flange assembly

#### 6.6.3.1 Port flange assembly without insert

Install the hose in position and protruding 30 mm from the pump housing flange face (the side through which the hose had been inserted).

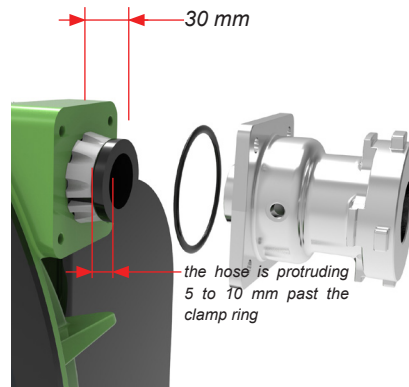

Figure 10. - Port flange without insert

#### 6.6.3.2 Port flange assembly with insert

Hose is in position and protruding 30 mm from the pump housing flange face (the side through which the hose had been inserted).

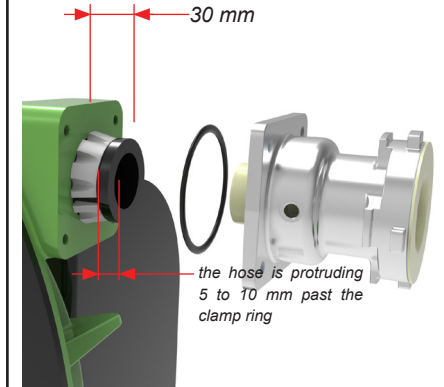

Figure 11. - Port flange with insert

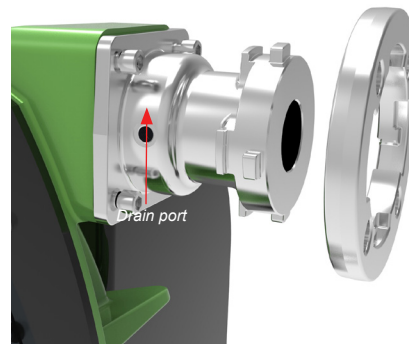

Figure 12. - Drain port without insert

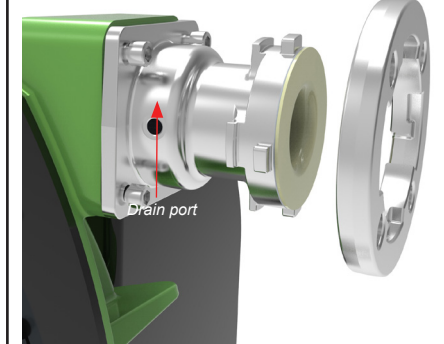

Figure 13. - Drain port with insert

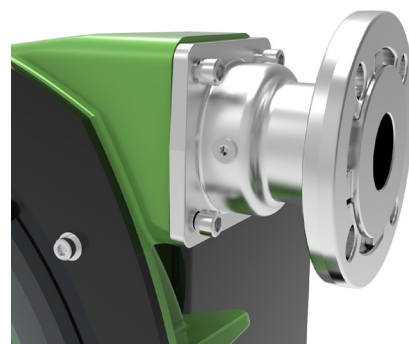

Figure 14. - Assembled without insert

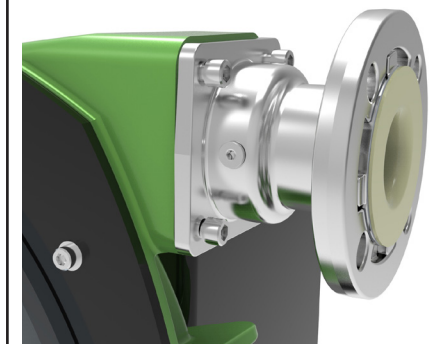



Figure 15. - Assembled with insert

## 6.7 Filling the pump with lubricant

 Safety data sheets for both Verderlube and Verdersil are available from the manufacturer for compatibility check.

1. Provide a suitable container to collect spilt lubricant.
2. Ensure compatibility of lubricant with the pumped liquid.
3. Fill the pump casing with lubricant to the lowest bolt hole of the inspection window (→Figure 16).

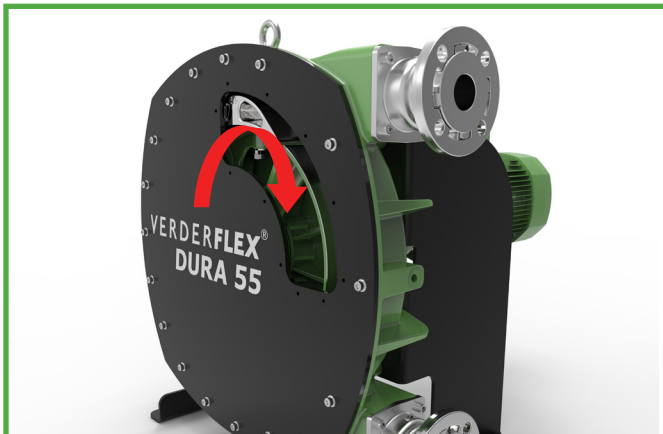

Figure 16. - Filling the pump with lubricant

### 6.7.1 Fitting the inspection window

1. Fit M6 cap head bolts with washers into the window. The window is threaded to make bolts captive and counter bored on the back face.
2. Mount the gasket on to the bolts.
3. Mount the window unit, with the bolts and gasket, over the front cover, aligned as shown in Figure 17.
4. Nip the bolts down in sequence. Ensure that the bolts are not over-tightened. (→11. Technical specifications)

You can see the gasket pressing against the window as the bolts clamping force takes effect.

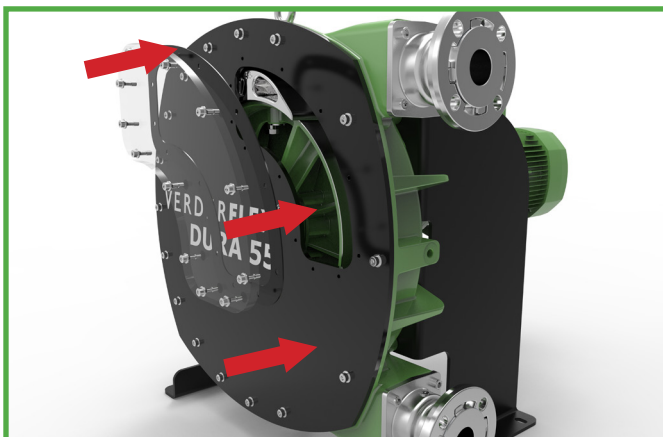

Figure 17. - Fitting the inspection window

## 6.8 Connecting the pipes

### Note

#### Contamination of pumped media due to impurities in the pump!

► Care should be taken to avoid ingress of contaminants into the pumped media.

- Clean all piping parts and fittings prior to assembly.
- Ensure that the flange seal do not protrude inwards occluding the flow path.
- Remove flange covers on both the suction and discharge side prior to installation.

### 6.8.1 Installing the piping

1. Check all fasteners are tightened (→11. Technical specifications).
2. Ensure that the 1/4 turn flange is correctly indexed.
3. Remove the transport and sealing covers from the pump.
4. Before connecting any piping to the pump; Ensure that the hose is properly secured by running the pump dry for 10–20 revolutions in both the directions.
5. Run the pipes in a continuous upward or downward slope to avoid air pockets.
6. Connect the piping.
7. Make sure that the nozzle loadings on flanges are not exceeded.

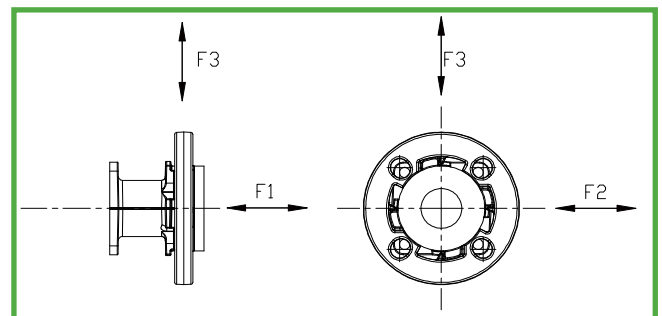

Figure 18. - Nozzle loadings on flanges

8. Consider the maximum nozzle loadings on flanges in the following table:

Pump Type	Maximum Nozzle Loadings (N)		
	F1	F2	F3
Dura 55/60	1500 N	1000 N	1000 N

Table 5. - Maximum nozzle loadings on flanges

## 7. Operation

### 7.1 Pre-commissioning the pump

#### 7.1.1 Checking the direction of rotation with dry pump

- Ensure the pump has lubricant in it.
- Switch the motor on and check the direction of rotation; then switch off immediately.
- If the direction of rotation is different: swap two of the phases (\*check with electrician)

#### 7.1.2 Starting the Pump

### DANGER

#### Risk of injury and poisoning due to pumped liquid spraying out!

- ▶ Use personal protective equipment when carrying out any work on the pump.

#### Equipment damage due to excess pressure!

- ▶ Do not operate the pump with the discharge-side fitting closed.
- ▶ Operate the pump only inside the tolerances specified by the manufacturer (→11. Technical specifications).

### WARNING

#### Risk of injury and poisoning due to hazardous pumped liquids!

- ▶ Safely collect any leaking pumped liquid and dispose of it in accordance with environmental rules and requirements.

#### Checklist:

- Pump set up and connected properly.
  - Motor set up and connected properly.
  - All connections stress-free and sealed.
  - Pump housing lubricant level correct (→6.7 Filling the pump with lubricant).
  - All safety equipment installed and tested for functionality.
1. Close all drainage taps.
  2. Open the suction-side and the discharge-side fittings.
  3. Switch ON the motor and make sure it is running smoothly.
  4. Run the pump, flushing with water first (cold commissioning) to check for leaks.
  5. Verify that neither the pump nor the pipe connections are leaking.
  6. Perform a second flush by running the pump, 10–20 revolutions with pumped liquid, to remove residue and water inside the pump.

### 7.1.3 Switching OFF the pump

### WARNING

#### Risk of injury due to hot pump parts!

- ▶ Use personal protective equipment when carrying out any work on the pump.

### Note

#### Risk of dead heading and hose burst due to closed suction or discharge!

- ▶ Keep the suction and discharge side fittings opened till the rotor has come to a complete stop.

#### Equipment damage due to sediments!

- ▶ If the pumped liquid crystallizes, polymerizes or solidifies:
  - Flush pump
  - Make sure that the flushing liquid is compatible with the pumped liquid.

1. If necessary: Flush and empty the pump.
2. Switch off power to the motor.
3. Close the discharge side fitting.
4. Check all tie bolts and tighten them if necessary (only after putting the pump into service for the first time).

## 7.2 Commissioning the pump

### 7.2.1 Switching ON the Pump



**DANGER**

#### Risk of injury due to running pump!

- ▶ Do not touch the moving parts of a running pump.
- ▶ Do not carry out any repair/ maintenance work on the running pump.
- ▶ Allow the pump to cool down completely before starting any work on the unit.

#### Risk of injury and poisoning due to pumped liquid spraying out!

- ▶ Use personal protective equipment when carrying out any work on the pump.

### Note

#### Risk of pulsation when throttling down the suction flow rate!

- ▶ Fully open the suction-side fitting and DO NOT use it to adjust the flow as this could damage the hose.

#### Checklist:

- Pump pre-commissioned (→7.1 Pre-commissioning the pump).
- Pump prepared and filled.

1. Open the suction-side and the discharge-side fittings.
2. Switch on the motor and make sure it is running smoothly.

### 7.2.2 Switching OFF the pump (refer to 7.1.3)



**WARNING**

#### Risk of injury due to hot pump parts!

- ▶ Use personal protective equipment when carrying out any work on the pump.

### Note

#### Damage to hose due to sediments!

- ▶ If the pumped liquid crystallizes, polymerizes or solidifies:
  - Flush the hose
  - Make sure that the flushing liquid is compatible with the pumped liquid.

## 7.3 Shutting down the pump

- ▶ Take the following measures whenever the pump is shut down:

Pump is...	Measure
shut down	▶ Take measures according to the pumped liquid (→Table 7. - Measures depending on the behaviour of the pumped liquid).
dismounted	▶ Isolate the motor from its power supply and secure it against unauthorized switch-on.
put into storage	▶ Follow the storage instructions (→4.2 Storage conditions)

Table 6. - Measures to be taken if pump is shut down

Behaviour of the Pumped Liquid	Duration of Shutdown (Depending on Process)	
	Short	Long
Crystallized or polymerized, solids sedimenting	▶ Flush the pump	▶ Flush the pump, remove the hose
Solidifying non-corrosive	▶ Heat up or empty the pump	▶ Empty the pump
Solidifying corrosive	▶ Heat up or empty the pump	▶ Empty the pump ▶ Treat the pump with preservative
Liquid, non-corrosive	-	-
Liquid, corrosive	▶ Empty the pump	▶ Empty the pump ▶ Treat the pump with preservative

Table 7. - Measures depending on the behaviour of the pumped liquid

## 7.4 Start-up following a shutdown period

1. After a prolonged shutdown period, re-commission the pump as follows:
  - Replace the seals
  - Install or change hose (→6.5 Installing the hose).
2. Carry out all steps as for the initial start-up (→7.1 Pre-commissioning the pump).

## 7.5 Operating the standby pump

#### Checklist:

- Standby pump is filled with lubricant (→6.7 Filling the pump with lubricant).
- ▶ Operate the standby pump at least once a week to avoid formation of permanent dents/setting on the hose.

## 8. Inspection, Maintenance and Repair

-  Only trained service technicians should be employed for fitting and repair work. Present a pumped medium certificate (DIN safety data sheet or safety certificate) when requesting service.

### DANGER

#### Risk of injury due to running pump or hot parts!

- ▶ Do not carry out any repair/maintenance work on a pump in operation.
- ▶ Allow the pump to cool down completely before starting any repair work.
- ▶ If inspection cover is removed for cleaning the pump cavity, isolate the power supply until inspection cover is replaced.

#### Risk of injury due to pressure buildup!

- ▶ Do not carry out any repairs/maintenance work on a pump in operation.
- ▶ Do not block the breather tube which is designed for pressure relief.
- ▶ In the unlikely event of a hose burst which leads to blockage of the breather tube - safely relieve the pressure inside the casing before disassembling the pump.

### WARNING

#### Risk of injury and poisoning due to hazardous pumped liquids!

- ▶ Use protective equipment when carrying out any work on the pump.

### 8.1 Inspection

-  The inspection intervals depend on the pump operating cycle.

1. Check at appropriate intervals:
  - Normal operating conditions unchanged
2. For trouble-free operation, always check the following:
  - Lubricant level
  - No leaks
  - No unusual running noises or vibrations
  - Hose in position

### 8.2 Maintenance

-  These pumps are generally maintenance-free and any work should normally be limited to inspections and pump lubricant changes as required; these may be more frequent in dust and/or hot condition.

### 8.2.1 Cleaning the pump

#### DANGER

##### Risk of electrocution!

- ▶ Have all electrical work carried out only by qualified electricians.

#### Note

##### High water pressure or spray water can damage motors!

- ▶ Do not clean motors with water or steam jet.

1. Clean large-scale grime from the pump.
2. Rinse the hose carefully to remove chemicals (follow the cleaning protocol as listed in (→8.2.2 Cleaning protocol for hoses).

### 8.2.2 Cleaning protocol for hoses

VERDERFLEX hoses should be cleaned with the following protocol –

#### NBR, NR and CSM Hoses:

- ▶ VERDERFLEX NBR, NR and CSM hoses should be cleaned with the following protocol:
  1. First flush 0.5% Nitric Acid (HNO<sub>3</sub>) solution at up to 50°C, max 10-15 minutes
  2. Second flush 5% Caustic soda (NaOH) solution at up to 50°C, max 10-15 minutes and eventually steamed open ends for 15 minutes at up to 110°C
  3. Final flush: flush with clean water to remove all traces of cleaning solutions

#### EPDM Hoses:

- ▶ VERDERFLEX EPDM hoses should be cleaned with the following protocol:
  1. First flush 0.5% Nitric Acid (HNO<sub>3</sub>) solution at up to 50°C, max 10-15 minutes
  2. Second flush 5% Caustic soda (NaOH) solution at up to 50°C, max 10-15 minutes and eventually steamed open ends for 15 minutes at up to 130°C
  3. Final flush: flush with clean water to remove all traces of cleaning solutions

## NBRF Hoses:

- ▶ VERDERFLEX NBRF food grade hoses should be sterilised using the following methods:

If using steam:

Steam for 15 minutes, open ended (max. 110°C).

If using chemicals:

Chemical	Method
Nitric acid: ▶ 3% max. ▶ 0.1 max.	30°C for 10 minutes 50°C for 10 minutes
Phosphoric acid (5% max.)	50°C for 15 minutes
Hydrogen peroxide ▶ 3% max. ▶ 1% max.	30°C for 10 minutes 50°C for 10 minutes
Peracetic acid (0.5% max.)	30°C for 10 minutes
Sodium hydroxide ▶ 2% max. ▶ 5% max.	70°C for 10 minutes 30°C for 10 minutes
Chlorine (1% max.)	70°C for 15 minutes

## Note

After every sanitisation cycle - rinse the hose with water.

Under no circumstances should VERDERFLEX NBRF food grade hoses be cleaned with Sodium Hypochlorite (NaOCl) based cleaning solutions, neither should the above concentrations, exposure, durations or temperatures be exceeded.

### ▶ Food Grade Approval

All VERDERFLEX NBRF food grade hoses' inner liners are certified as compliant to:

- FDA – CFR 21 Parts 170 to 199 – Item 177.2600
- EC regulation No.1935/2004
- EC regulation No.2023/2006

### ▶ Hose Description

All VERDERFLEX NBRF food Grade hoses consist of a smooth black inner food grade liner bonded to a non-food grade outer. The inner liner is a taste-free and odourless.

### ▶ Hose Installation

All VERDERFLEX NBRF food Grade hoses must be installed in accordance with the procedures defined in the VERDERFLEX Operating and Maintenance manual.

### ▶ Identification

VERDERFLEX NBRF food Grade hoses can be identified by: Both an external Yellow Coding / Identification tape and an additional white longitudinal stripe. The hose will also have glass fork symbol as per Regulation (EC) 1935/2004.

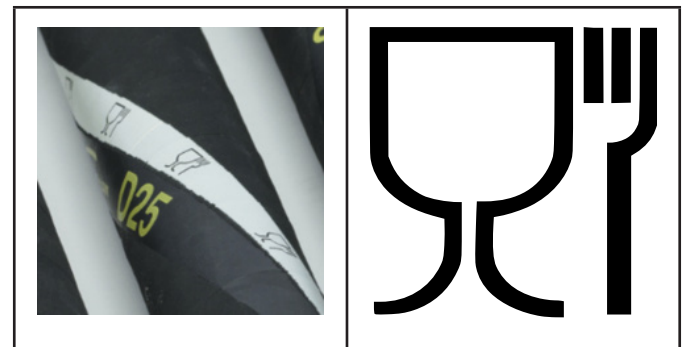

Figure 19. - Verderflex NBRF food grade hose identification

### ▶ Pump Installation

VERDERFLEX pumps using VERDERFLEX NBRF Food Grade hoses must be installed in accordance with recommendations made by the pump's supplier. In particular, special care must be given to the suction and discharge line conditions and that the hose is shimmed in accordance with VERDERFLEX's recommendations. Should there be any doubt about any installation details, these must be discussed with the pumps' supplier.

### ▶ Particle Release

All hoses will release small quantities of rubber into the product stream, especially immediately after the hose installation and just prior to hose failure. Whilst the rubber released will be food grade particles, these may cause end-user concerns about contamination and so we recommend suitable particle capturing devices such as filters are fitted into the pump's discharge line.

## 8.2.3 Maintenance schedule

Task	Frequency	Action
Check pump and gearbox for leaks and damage	<ul style="list-style-type: none"> <li>– Before pump start up</li> <li>– Daily visual inspection</li> <li>– Scheduled intervals during operation</li> </ul>	<ul style="list-style-type: none"> <li>▶ Repair leaks and damage before operating the pump</li> <li>▶ Replace components as necessary.</li> <li>▶ Clean up any spillage.</li> </ul>
Check pump housing lubrication level	<ul style="list-style-type: none"> <li>– Before pump start up</li> <li>– Daily visual inspection</li> <li>– Scheduled intervals during operation</li> </ul>	<ul style="list-style-type: none"> <li>▶ <b>Make sure that lubricant level is visible in the inspection window between the lower sill and the first pair of bolts.</b></li> <li>▶ Do not operate the pump if the level is too low or too high. Refill lubricant as required (→6.7 Filling the pump with lubricant)</li> </ul>
Check geared motor unit lubrication level	<ul style="list-style-type: none"> <li>– Before pump start up</li> <li>– Daily visual inspection</li> <li>– Scheduled intervals during operation</li> </ul>	<ul style="list-style-type: none"> <li>▶ → Motor instruction manual.</li> </ul>
Check pump for unusual temperatures or noise in operation	<ul style="list-style-type: none"> <li>– Daily visual inspection</li> <li>– Scheduled intervals during operation</li> </ul>	<ul style="list-style-type: none"> <li>▶ Check pump, gearbox and bearing housing for damage.</li> <li>▶ Replace worn components.</li> </ul>
Replace pump housing lubricant	<ul style="list-style-type: none"> <li>– <b>At every hose change or every six months</b></li> <li>– <b>After inspection when required</b></li> </ul>	<ul style="list-style-type: none"> <li>▶ Refill lubricant (→6.7 Filling the pump with lubricant)</li> </ul>
Replace hose	<ul style="list-style-type: none"> <li>– After inspection when required</li> <li>– When flow has dropped by 25% of nominal value</li> <li>– When the hose is burst/damaged</li> </ul>	<ul style="list-style-type: none"> <li>▶ Replace hose (→8.4 Hose change)</li> <li>▶ Replace flange sealing kit</li> </ul>
Check pump housing, rotor, rotor shoes and inserts internally	<ul style="list-style-type: none"> <li>– Annually</li> <li>– On replacing the hose</li> </ul>	<p>Worn and damaged surfaces give rise to premature hose failure</p> <ul style="list-style-type: none"> <li>▶ Replace worn components.</li> <li>▶ Check bearing play and function.</li> </ul>
Replace bearing and seal	<ul style="list-style-type: none"> <li>– After 30,000 running hours</li> <li>– When damage is suspected</li> <li>– When leak is detected</li> </ul>	<ul style="list-style-type: none"> <li>▶ Check bearing play and function.</li> <li>▶ Replace worn components.</li> </ul>

Table 8. - Maintenance schedule

## 8.3 Repair



### DANGER

#### Risk of death due to electric shock!

- ▶ Have all electrical work carried out by qualified electrician only.



### WARNING

#### Risk of injury due to heavy components!

- ▶ Pay attention to the component weight. Lift and transport heavy components using suitable lifting gear.
- ▶ Set down components safely and secure them against overturning or rolling away.

#### Risk of injury while dismantling the pump!

- ▶ Use protective equipment when carrying out any work on the pump.
- ▶ Observe manufacturer's instructions (e.g., for motor, coupling, gearbox).

### 8.3.1 Preparations for dismantling

#### Checklist:

- Safely release any pressure build-up in the pump housing (There may be significant built up of pressure in the discharge line or possible suction side vacuum).
- Pump completely emptied, flushed and decontaminated.
- Electrical connections disconnected and motor locked out against being switched on again.
- Pump cooled down.
- Auxiliary systems shut down, depressurized and emptied.
- Before dismantling the pump, mark the precise orientation and position of all components before dismantling them.

### 8.3.2 Returning the pump to the manufacturer

#### Checklist:

- Pump unpressurized.
- Completely emptied and decontaminated.
- Pump cooled down.
- Hose dismantled. (→8.4.1 Dismounting the hose)

#### Obtain prior authorization before repair or return of the pump.

- ▶ Enclose a completed document of compliance when returning pumps or components to the manufacturer.
- ▶ Please contact Verder Ltd. internal sales department for a copy of the Return of Goods form.
- ▶ Returning without the Return of Goods form will not be accepted.

Repairs	Measure for Return
...at the customer's premises	<ul style="list-style-type: none"> <li>– Return the defective component to the manufacturer.</li> <li>– Decontaminate if necessary.</li> </ul>
...at the manufacturer's premises	<ul style="list-style-type: none"> <li>– Flush the pump and decontaminate it if it was used for hazardous pumped liquids.</li> </ul>
...at the manufacturer's premises for warranty repairs	<ul style="list-style-type: none"> <li>– Only in the event of hazardous pumped liquid, flush and decontaminate the pump</li> </ul>

Table 9. - Measures for returning the pump to the manufacturer

### 8.3.3 Rebuild / Repair

- Reinstall the components, in accordance with the marks applied.

## Note

#### Material damage due to unsuitable components!

- ▶ Always replace lost or damaged bolts with bolts of the same strength and material.

- Observe the following during the installation:
  - Replace worn parts with genuine spare parts.
  - Maintain the prescribed tightening torques (→11. Technical specifications)
- Clean all parts (→11. Technical specifications). Do not remove any markings which have been applied.
- Reassemble the pump.
- Install the pump in the system (→6. Installation and Connection).



## 8.4 Hose change



### WARNING

#### Risk of injury!

- ▶ Always isolate the power supply before working on the pump.



The hose change involves removal and re-installing the port flanges.

### 8.4.1 Dismounting the hose

#### 8.4.1.3 Draining lubricant

##### Checklist:

- Motor isolated.
- System secured against being switched back on again.



### WARNING

#### Slip hazard due to spilt lubricant!

- ▶ Care must be taken when lubricant is drained into a container.
- ▶ Dispose of used lubricant in accordance with local laws and good environmental practices.

1. Remove the drain plug at the rear of the pump.
2. Drain the lubricant into a suitable container.
3. Remove the lower flange and allow any excess lubricant to drain out.

#### 8.4.1.4 Removing the hose



### CAUTION

#### Risk of injury if the hose is expelled too quickly!

- ▶ Slowly remove the hose by running the motor at a reduced speed

1. Remove both the flanges. Remove and dispose of both clamp rings (where fitted).
2. Use the motor to drive out the old hose. If no power is available, remove the fan cover and turn the fan shaft by hand or using suitable leverage. Care must be taken not to damage the fan blades when using this method.
3. Clean the pump housing.
4. Inspect the flanges for damage and signs of wear.

### 8.4.2 Re-installing the hose, port flanges, lubricant refill and fitting the inspection window

- Follow step by step, the instructions listed in section (→6. Installation and Connection)

## 8.5 Ordering spare parts



For trouble-free replacement in the event of faults, we recommend keeping spare parts available on site.

- ▶ The following information is mandatory when ordering spare parts (→ 5.2.1 Name plate):
  - Pump model
  - Year of manufacture
  - Part number / Description of part required
  - Serial number
  - Quantity



## 9. Troubleshooting

### 9.1 Pump malfunctions

If malfunctions occur which are not specified in the following table or cannot be traced back to the specified causes, please consult the manufacturer.

Possible malfunctions are identified and respective cause and remedy are listed in the table.

Abnormally high pump temperature	Low flow/pressure	Pump and pipework vibrating	Hose pulled in to pump housing	Possible cause	Solution
X	-	-	-	Incorrect lubricant	▶ Consult the manufacturer to obtain correct lubricant.
				Low lubricant level	▶ Add required amount
				Product ambient temperature too high	▶ Consult the manufacturer regarding maximum temperature
				Over shimming of the pump	▶ Check for and remove excess shims
X	X	-	-	Blocked suction / bad suction characteristics / no product	<ul style="list-style-type: none"> <li>▶ Check pipework and valves for blockages.</li> <li>▶ Check that the suction pipework is as short and as large in diameter as feasible</li> <li>▶ Correct the piping layout</li> <li>▶ Consult the manufacturer</li> </ul>
X	-	X	-	High pump speed	<ul style="list-style-type: none"> <li>▶ Reduce speed to a minimum</li> <li>▶ Consult the manufacturer</li> </ul>
-	X	-	-	Suction / discharge valve closed	▶ Open suction / discharge valve
				Hose failure	▶ Replace hose (→8.4 Hose change)
				Poor pump selection, incorrect shoe shimming	▶ Consult the manufacturer to check pump selection
				Suction line too long	▶ Consult the manufacturer
				Pump speed too high	▶ Consult the manufacturer
				Suction line bore too small	▶ Consult the manufacturer
				High product viscosity	▶ Consult the manufacturer
				Suction / discharge lines not secured properly	▶ Check and secure suction / discharge lines

Abnormally high pump temperature	Low flow/pressure	Pump and pipework vibrating	Hose pulled in to pump housing	Possible cause	Solution
-	-	X	-	Long suction / discharge lines / dampener malfunction	<ul style="list-style-type: none"> <li>▶ Shorten long suction / discharge lines wherever possible</li> <li>▶ Consult the manufacturer</li> </ul>
-	-	X	-	High product specific gravity / viscosity	<ul style="list-style-type: none"> <li>▶ Consult the manufacturer</li> </ul>
-	-	X	-	Under-sized suction / discharge diameter	<ul style="list-style-type: none"> <li>▶ Increase suction / discharge pipework diameter</li> <li>▶ Fit dampener</li> </ul>
-	-	X	-	Insufficient lubricant in the casing	<ul style="list-style-type: none"> <li>▶ Check lubrication chart and add the required amount of lubrication</li> </ul>
-	-	-	X	Inlet pressure too high	<ul style="list-style-type: none"> <li>▶ Reduce the inlet pressure</li> </ul>
-	-	-	X	Blocked hose / incorrectly fitted	<ul style="list-style-type: none"> <li>▶ Check the hose and remove any blockages</li> </ul>
-	-	-	X	Large particles in the product	<ul style="list-style-type: none"> <li>▶ Mount sieve or filter in suction line to avoid very large particles from entering the hose. Do not allow filters to limit suction below accepted levels.</li> </ul>

Table 10. - Pump troubleshooting list

## 10. List of Tables and Figures

### List of tables

Table 1. - Target groups	7
Table 2. - Warnings used in the manual	7
Table 3. - Symbols used in the manual	7
Table 4. - Dos and don'ts	14
Table 5. - Maximum nozzle loadings on flanges	18
Table 6. - Measures to be taken if pump is shut down	20
Table 7. - Measures depending on the behaviour of the pumped liquid	20
Table 8. - Maintenance schedule	23
Table 9. - Measures for returning the pump to the manufacturer	24
Table 10. - Pump troubleshooting list	28
Table 11. - Pump specifications	30
Table 12. - Tightening torques	30
Table 13. - Cleaning agents	30
Table 14. - Lubricant	30
Table 15. - Number of shims required	30
Table 16. - Rotor setting distance	30

### List of figures

Figure 1. - Fastening lifting gear to pump	10
Figure 2. - Name plate	11
Figure 4. - Removing the back plate support	15
Figure 5. - Installing the gearbox	15
Figure 6. - Installing the motor	15
Figure 7. - Shimming	16
Figure 8. - Installing the hose	16
Figure 9. - Clamp ring inserted	17
Figure 10. - Port flange without insert	17
Figure 11. - Port flange with insert	17
Figure 12. - Drain port without insert	17
Figure 13. - Drain port with insert	17
Figure 14. - Assembled without insert	17
Figure 15. - Assembled with insert	17
Figure 16. - Filling the pump with lubricant	18
Figure 17. - Fitting the inspection window	18
Figure 18. - Nozzle loadings on flanges	18
Figure 19. - Verderflex NBRF food grade hose identification	22

## 11. Technical specifications

### 11.1 Pump specifications

Size	Value
Max. delivery pressure	16 bar
Temperature of pumped liquid	< 100 °C < 40 °C (ATEX)
Max. continuous operation pump speeds	60 rpm at 0 bar 55 rpm at 6 bar 37 rpm at 10 bar 27 rpm at 16 bar
Dimensions	*(refer pump datasheet)

Table 11. - Pump specifications

NOTE: D60 parts are common to D55HF parts and specifications

### 11.2 Ambient conditions

 Operation under any other ambient condition would require approval from the manufacturer

#### Operating conditions

- Ambient temperature -5 °C to +45 °C
- Relative humidity (non-condensing) – long—term ≤ 85 %
- All units/calculations are based on operating conditions below ≤ 1000 m. For use above this height please check with manufacturer or local representative for confirmation of performance.

#### Storage conditions

- Ambient temperature +10 °C to +50 °C
- Relative humidity (non-condensing) – long—term ≤ 85 %

### 11.3 Tightening torques

 Tightening torques should be applied at the following torque values:

Position	Torque Values (Nm)
Inspection Window	3.4 Nm
Port Flange	90 Nm
Rotor Shoe	50 Nm
Gearbox to Pump Housing	65 Nm
Motor to Gearbox	65 Nm (301 gearbox size)
	90 Nm (303 gearbox size)
Frames to Casing	35 Nm
Front Cover	27 Nm
Keyless Bush	35 Nm
Seal Plate	3.4 Nm

Table 12. - Tightening torques

### 11.4 Preservatives

 Use RUST-BAN 335 or similar preservatives on bare metal.

### 11.5 Cleaning agents (after hose is removed)

Cleaning Agents
Wax solvents, diesel paraffin, alkaline cleaners, Warm Water

Table 13. - Cleaning agents

### 11.6 Lubricants

 Recommended lubricants for longer hose life are VERDERLUBE or VERDERSIL.

Pump Type	Amount of Lubricant
Dura 55/ 60	15 Litres (3.96 US Gallons)

Table 14. - Lubricant

## Note

The pump lubricant is filled to the lowest screw of the hole of the inspection window.

### 11.7 Number of shims required

 Number of shims required remains unaffected by change in rpm of the pump. Each shim is 0.5mm thick.

Hose Material	0 Bar	6 Bar	10 Bar	16 Bar
EPDM	2	3	5	6
NR	2	3	5	6
NBR	1	2	4	N/A
NBRF	1	2	N/A	N/A
CSM	1	2	4	6

Table 15. - Number of shims required

### 11.8 Rotor setting distance

 The rotor is factory aligned, but for maintenance or assembly from flat pack the rotor setting distance should be known.

Pump Type	Rotor Setting Distance
Dura 55/ 60	4mm from the front of casing to the front of rotor shoe

Table 16. - Rotor setting distance



## 12. Trademarks

VERDERFLEX® is a registered trademark of Verder Liquids B.V. No permission is granted to use any Verder, trademarks or trade names included in this document without the prior written agreement of Verder Liquids B.V.

Tri-clamp® is a registered trademark of Alfa Laval Corporate AB.

Hypalon® is a registered trademark of RSCC Wire & Cable LLC.

## 13. Document History

Version	Description	Date	Approved
00	Initial release, replaces D55HF manual	07/08/24	AJB